

# SZAFKA WYSOKA 1 DRZWI 80-30-1D

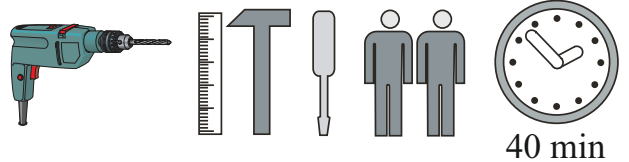

NO	Dim.			Col.-No	Qty
1	1400	236	16	1	2
2	268	235	16	1	2
3	268	212	16	1	1
4	268	204	16	1	2
5	1398	298	16	1	1
6	1376	278	3	1	1

3023667

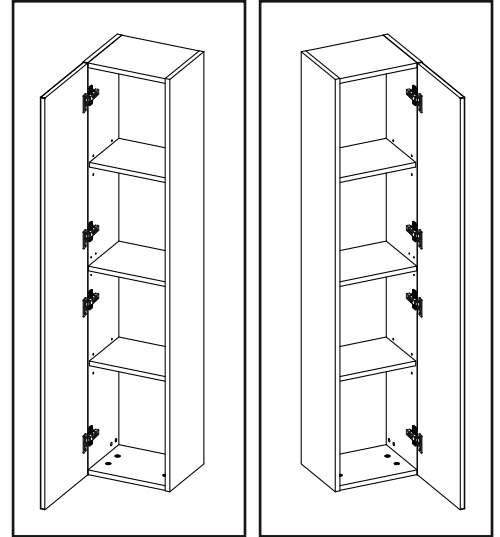
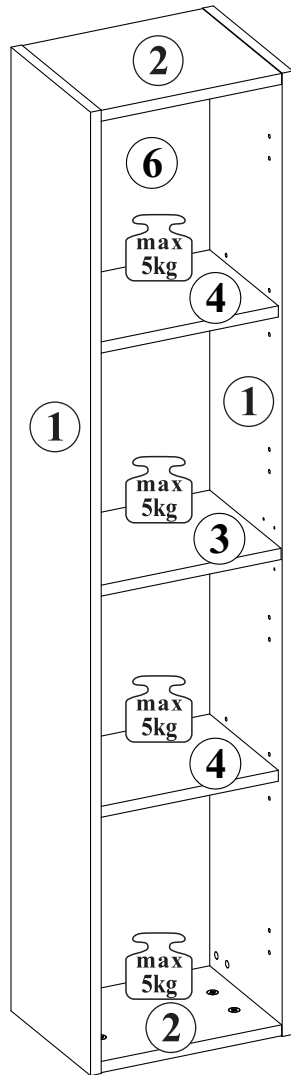
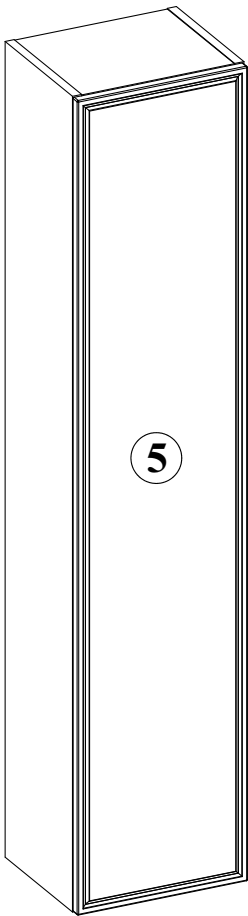
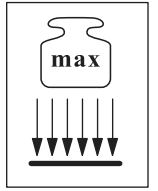

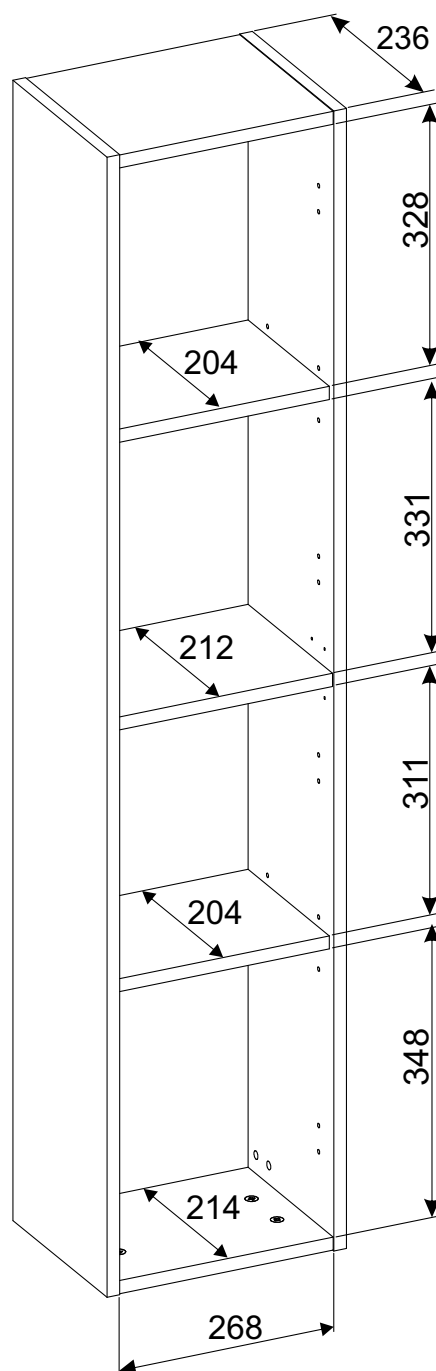
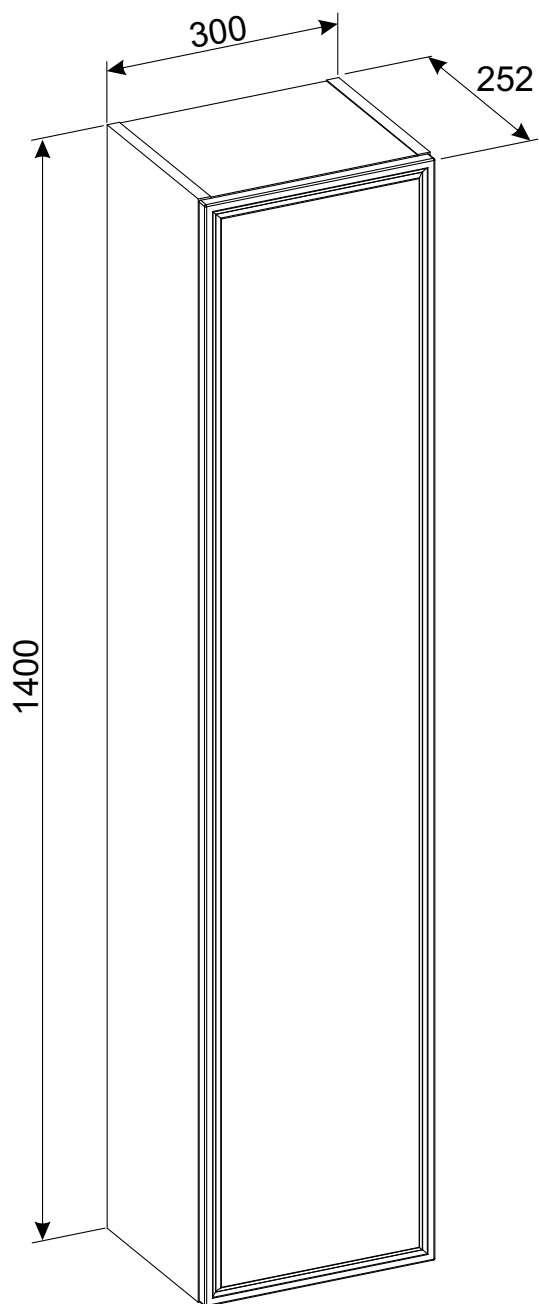



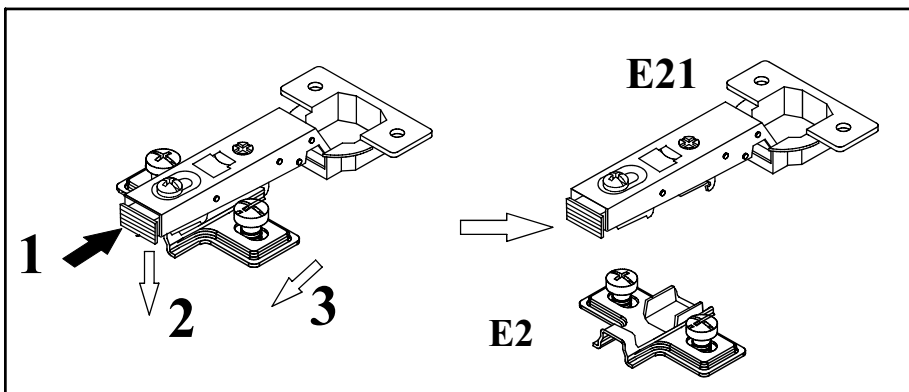
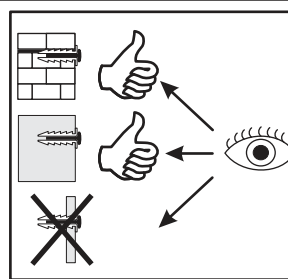
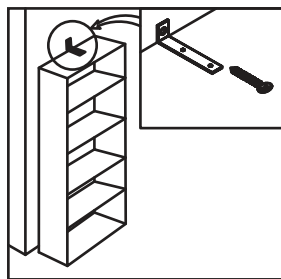
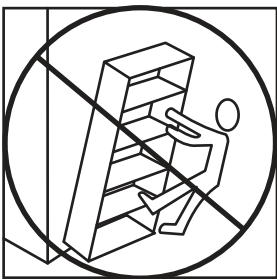
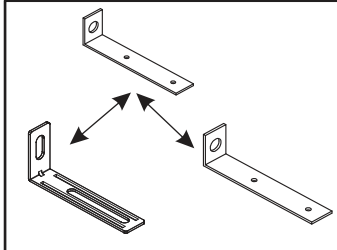
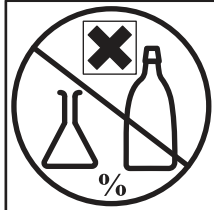
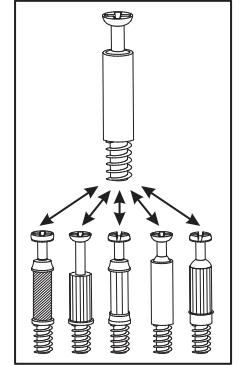
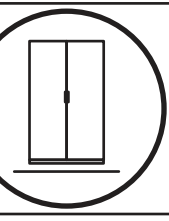
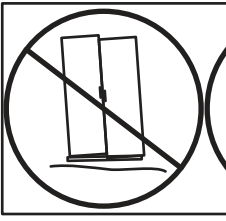
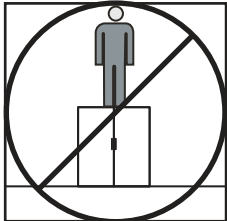
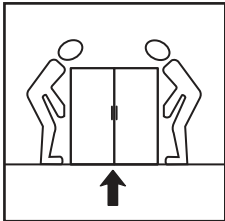
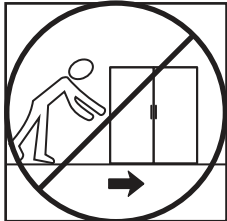
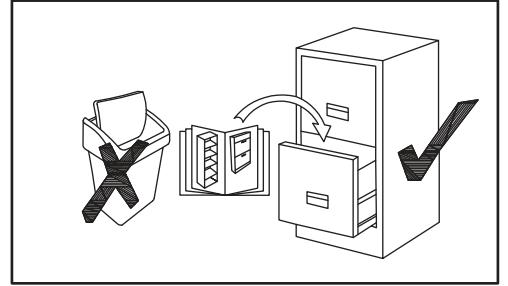
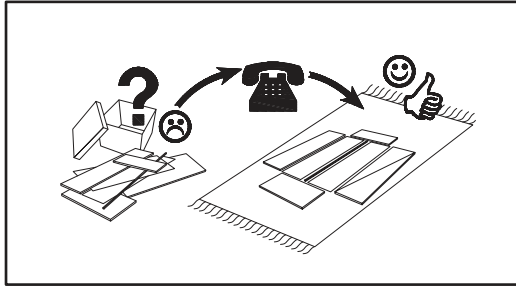
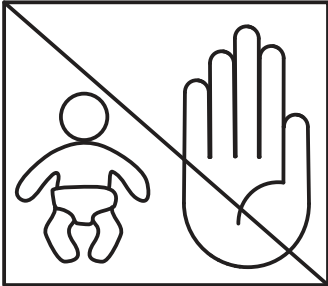
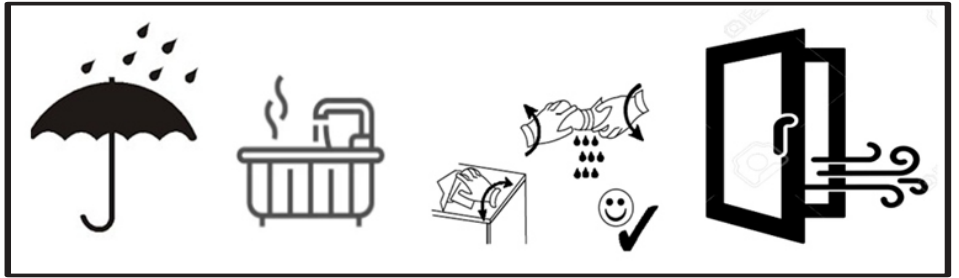
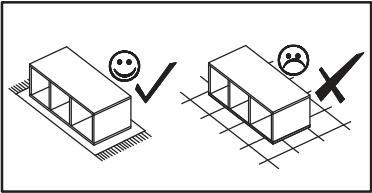
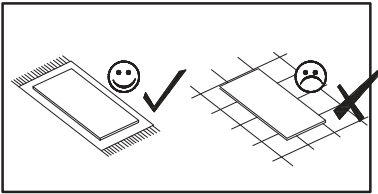

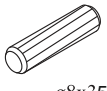
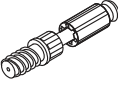

# SZAFKA WYSOKA 1 DRZWI 80-30-1D

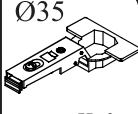
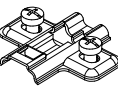

**SZAFKA WYSOKA  
1 DRZWI 80-30-1D**

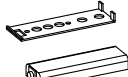

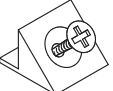
**SZAFKA WYSOKA  
1 DRZWI 80-30-1D**

A1 x12  ø8x35	B4 x12 	B5 x12  ø15x12	G5 x16 	ZXP x1 	ZXL x1 
E21 x4 Ø35 H=0 	E2 x4 H=0 	D10 x10 USØ3,5x16 	G7 x8 	G04 x1 	D6 x4 USØ4x30 
S1 x6 	SZ7 x2 	UP13 x3 UPØ3x20 			

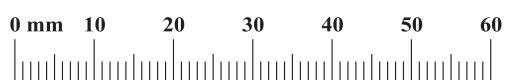

**SZAFKA WYSOKA  
1 DRZWI 80-30-1D**

**1**

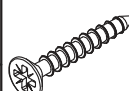
D6	
x4	USØ4x30

G5	
x4	

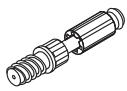
B4	
x12	

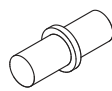
G7	
x8	

ZXP	
x1	

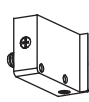
ZXL	
x1	

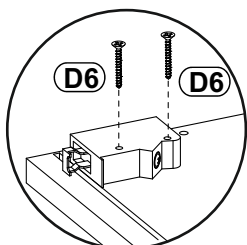
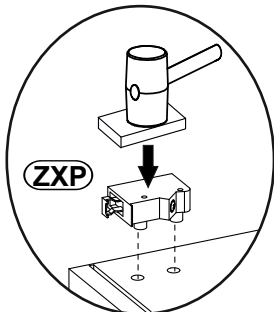
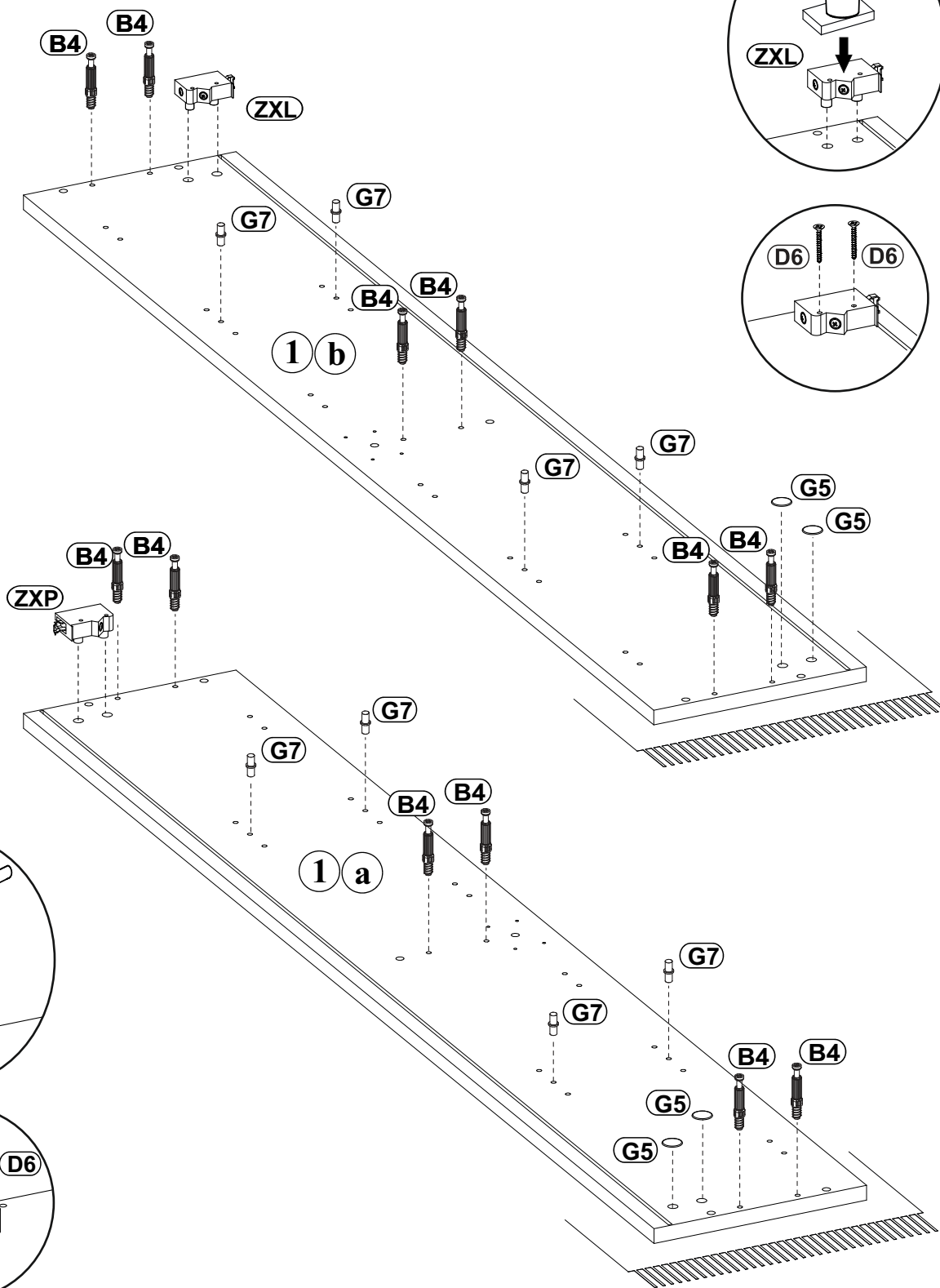
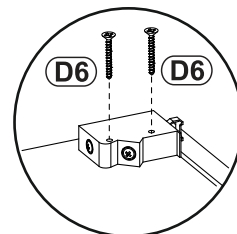
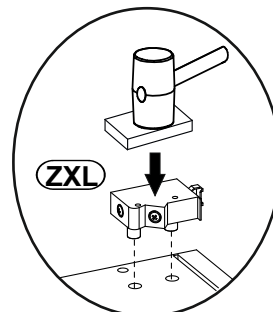
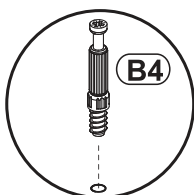
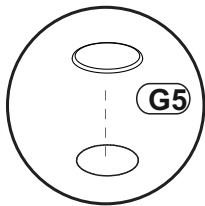
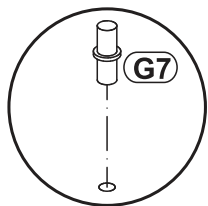

SZAFKA WYSOKA  
1 DRZWI 80-30-1D

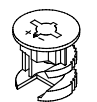

2

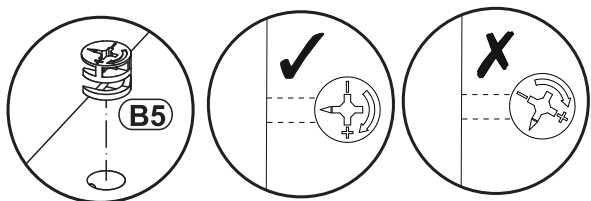
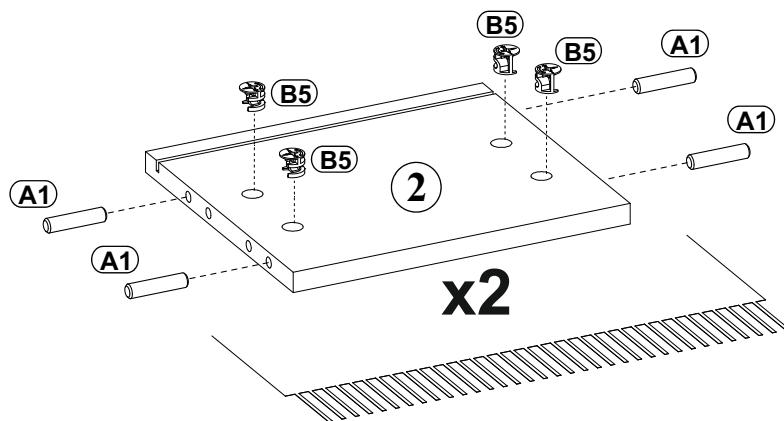
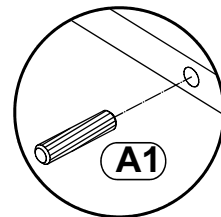
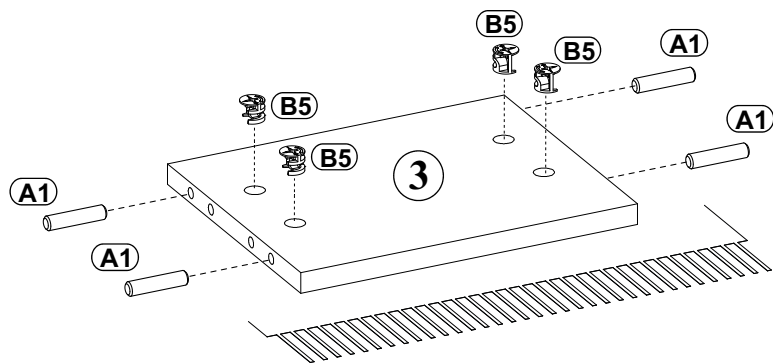
A1		B5	
x12	ø8x35	x12	ø15x12

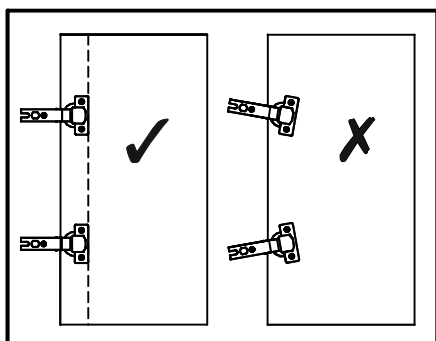

3

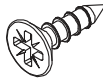

D10		E21	
x8	ø3,5x16	x4	Ø35 H=0

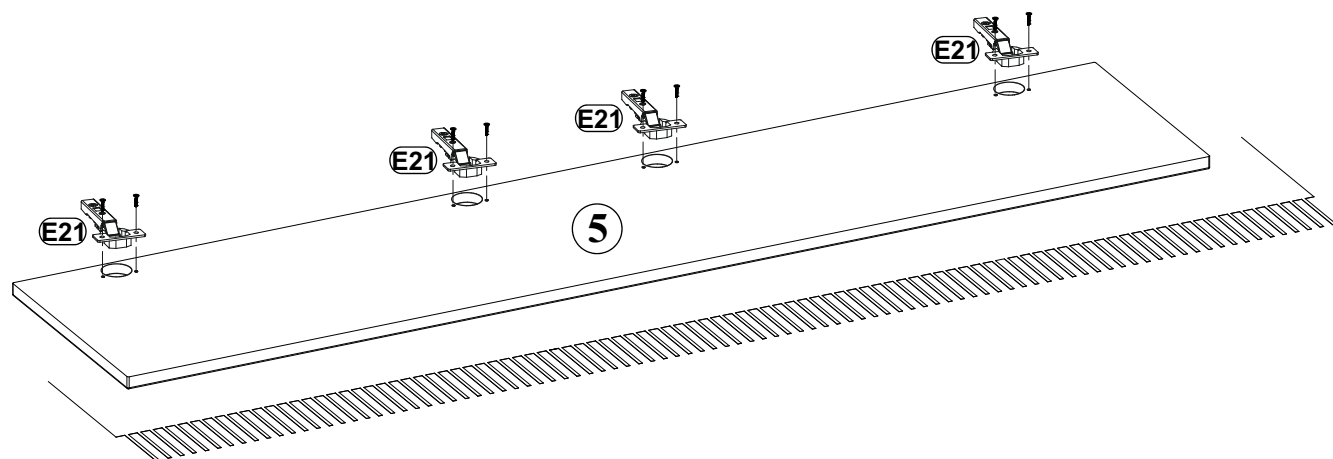
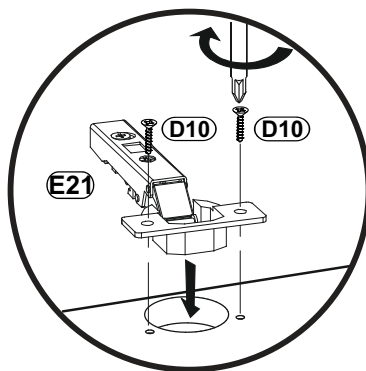

SZAFKA WYSOKA  
1 DRZWI 80-30-1D

G5	
x6	

4

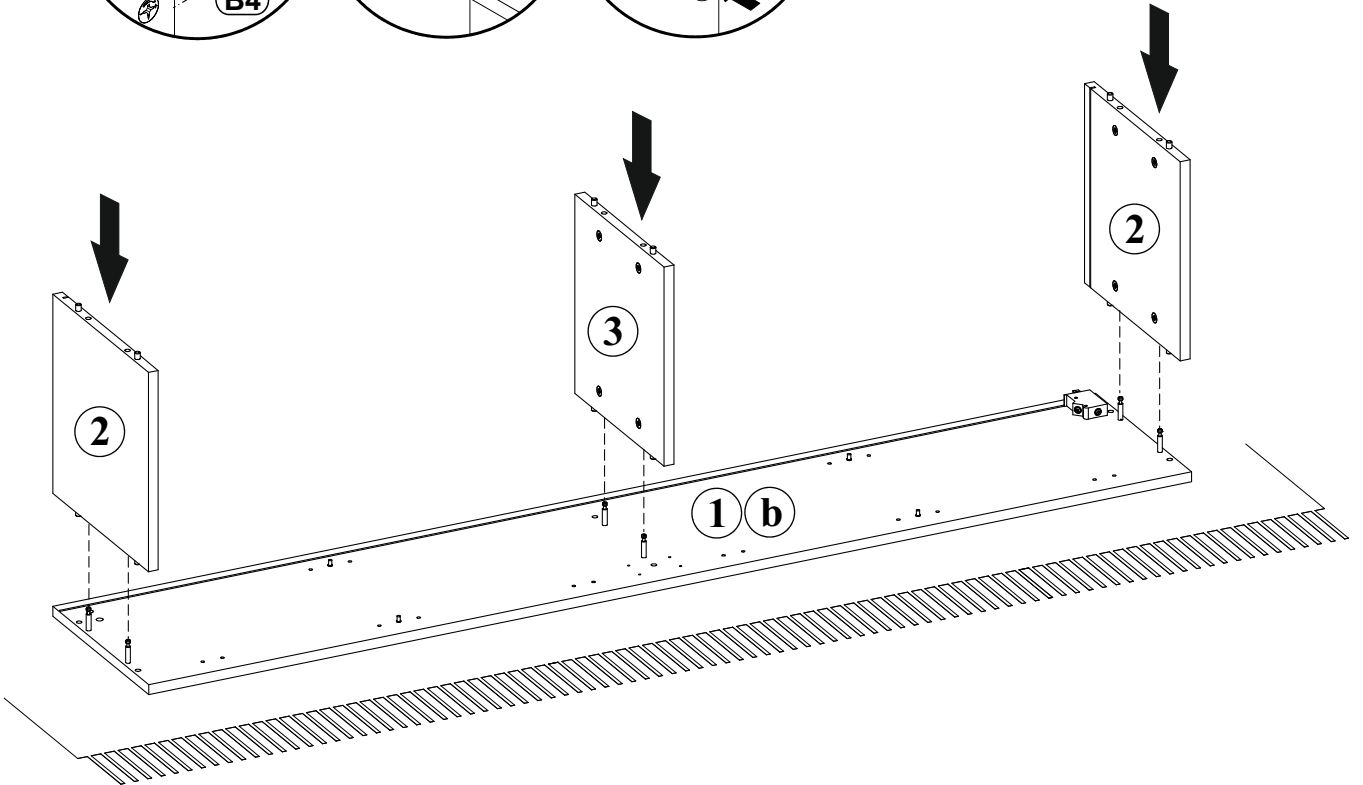
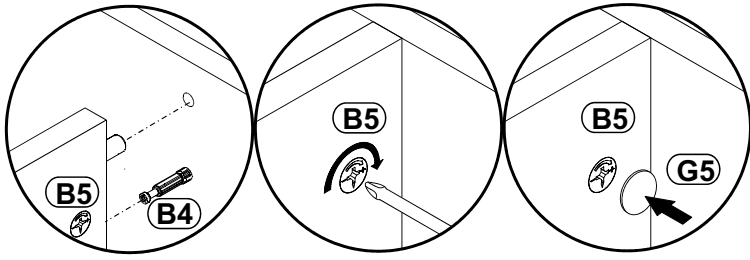

5

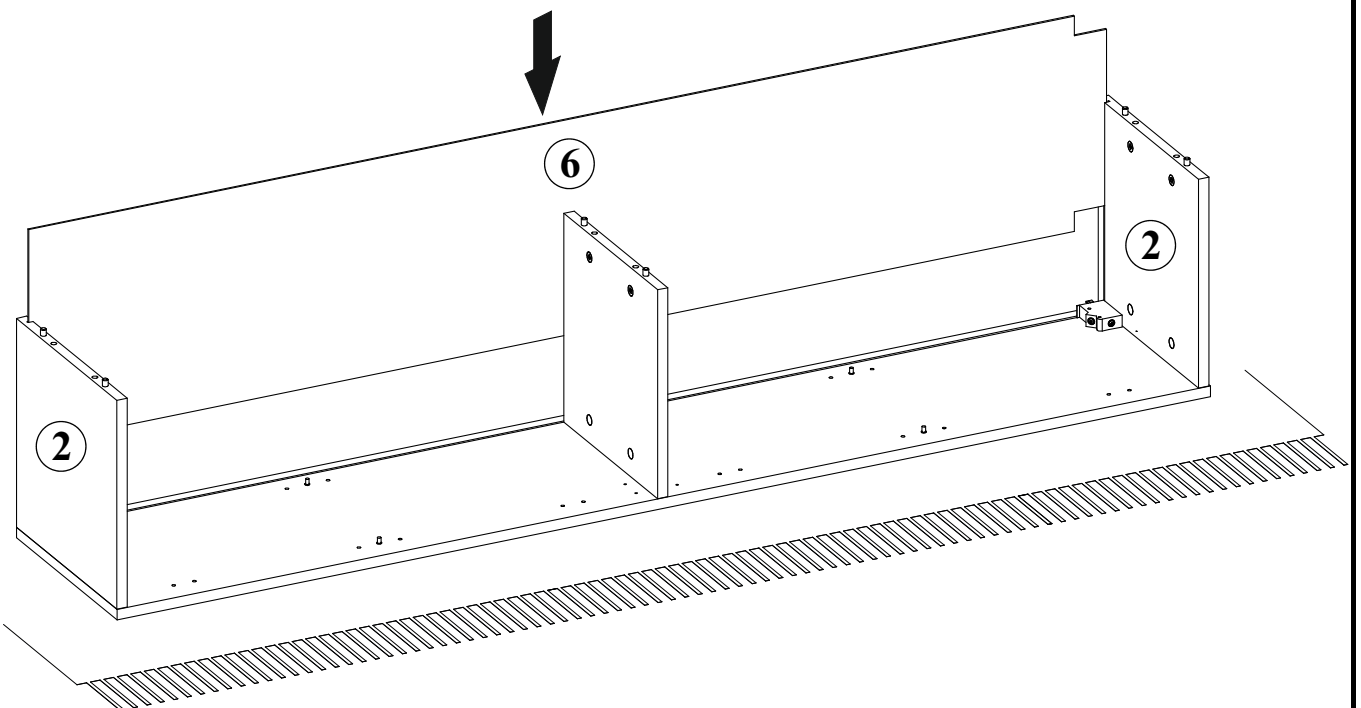

SZAFKA WYSOKA  
1 DRZWI 80-30-1D

G5	
x6	

6

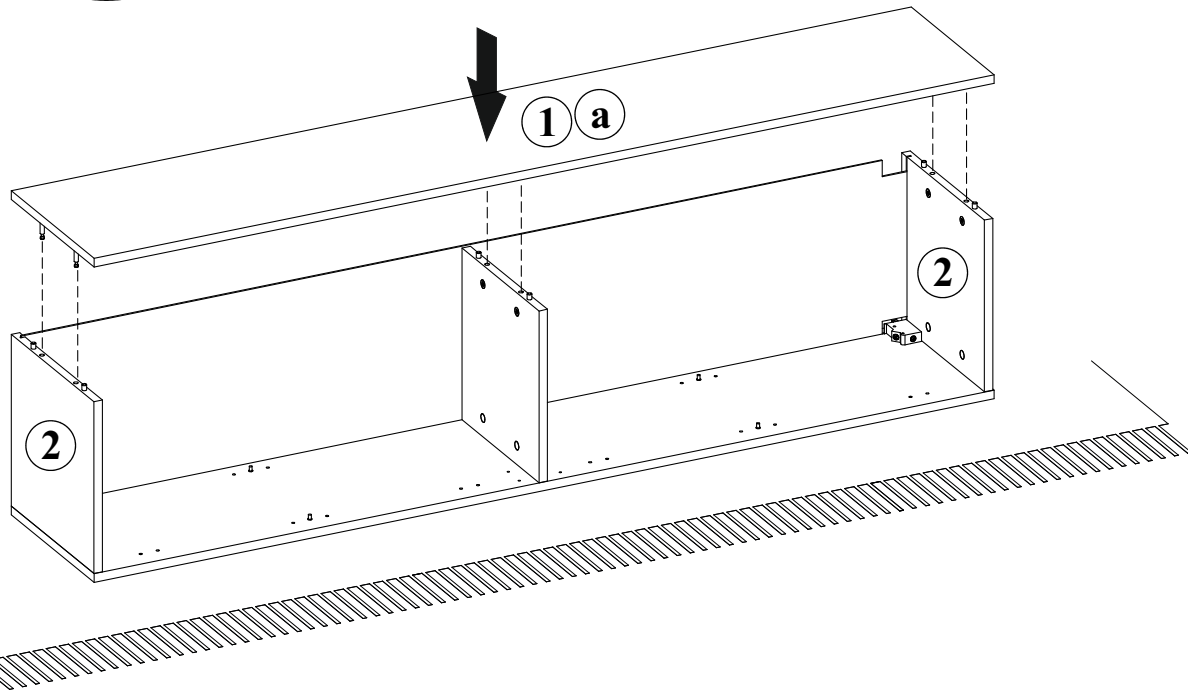
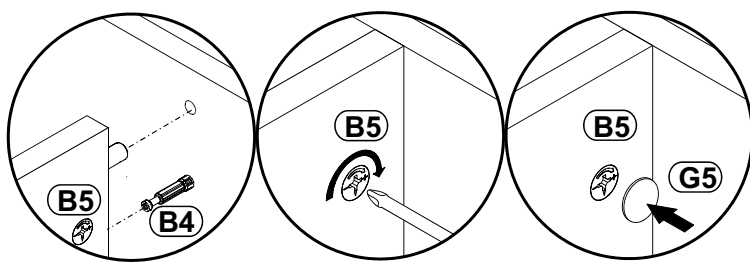

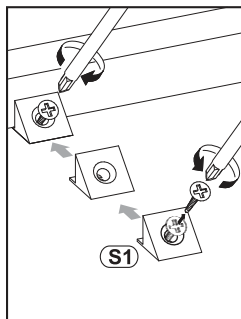

7

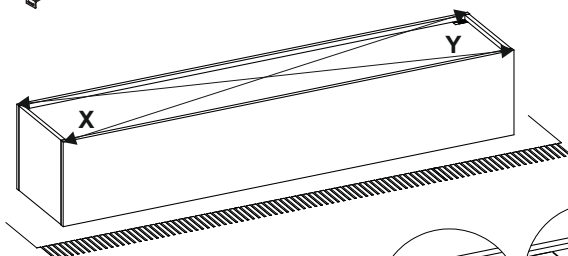

  $X=Y$   $\uparrow 90^\circ$

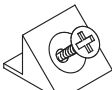

S1	
x6	

U13	
x3	UP $\varnothing 3 \times 20$

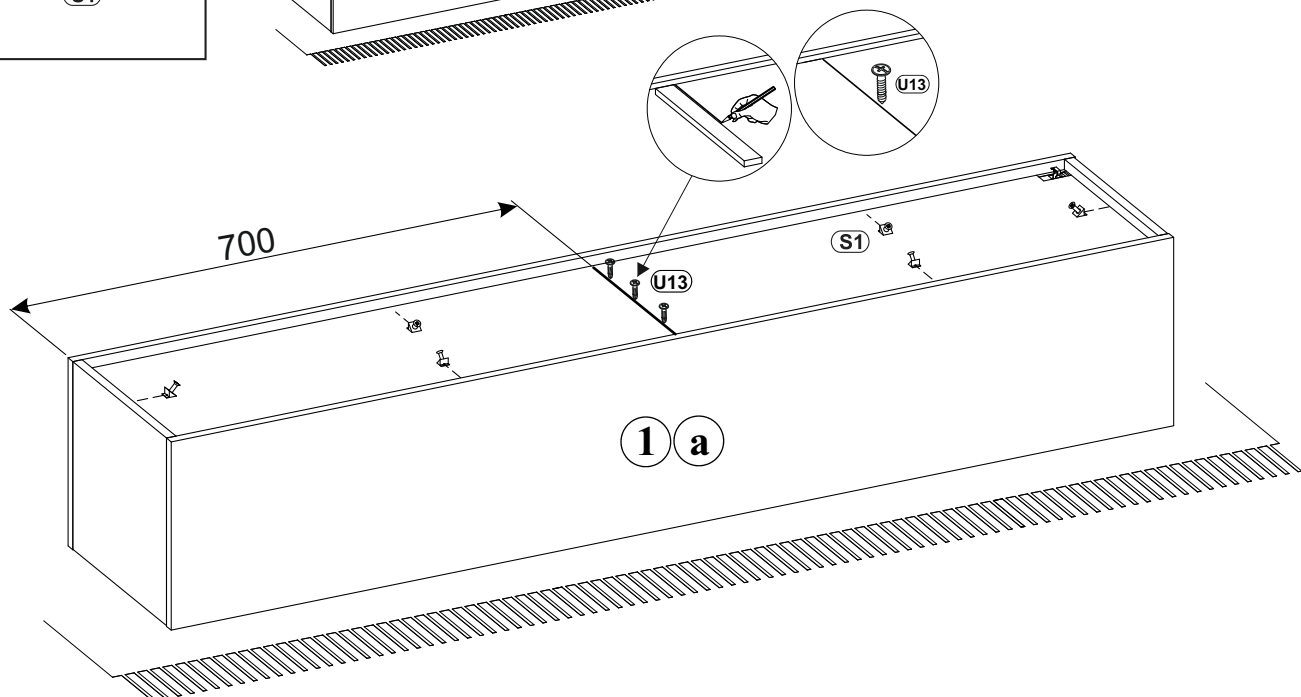

SZAFKA WYSOKA  
1 DRZWI 80-30-1D

8

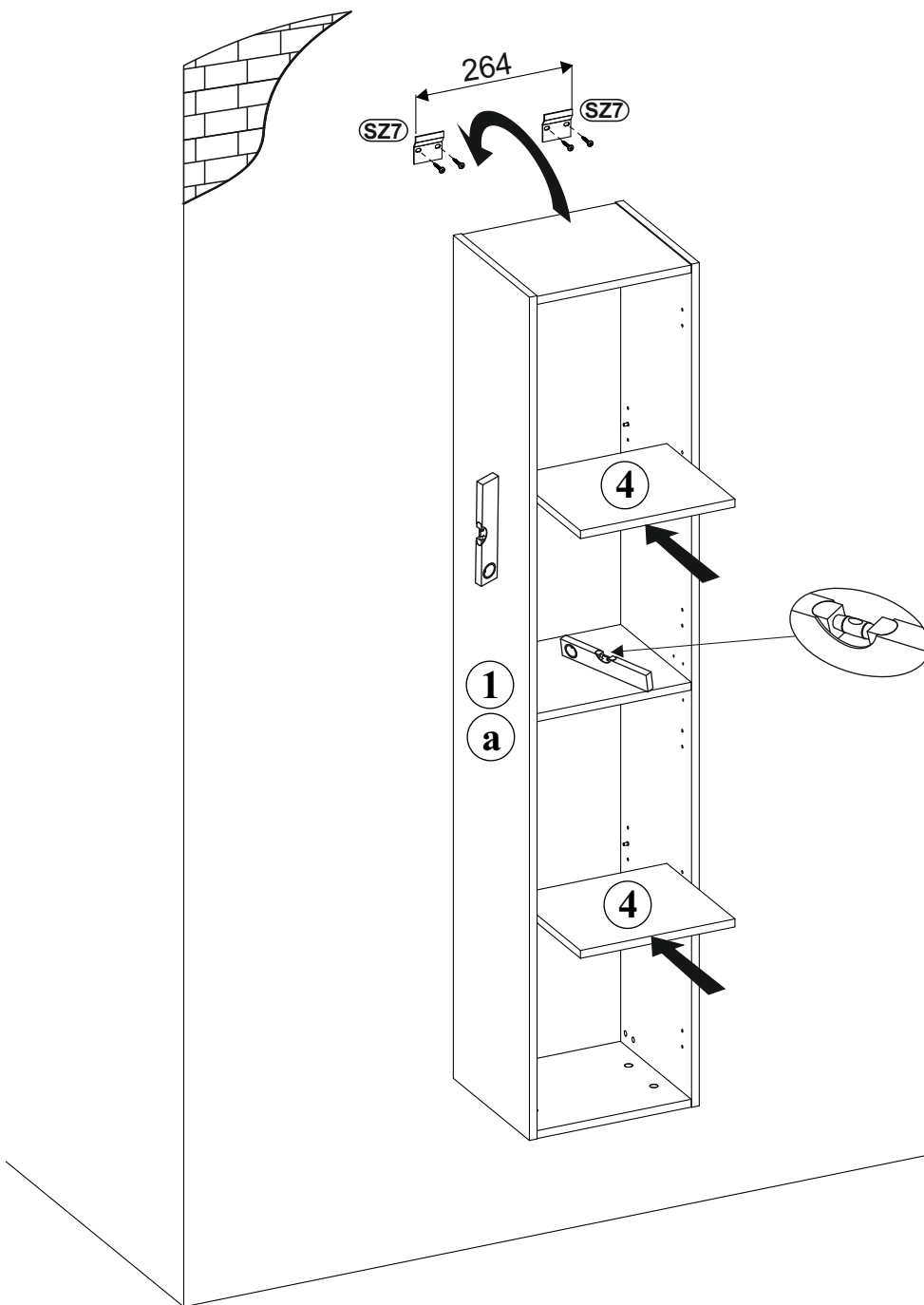
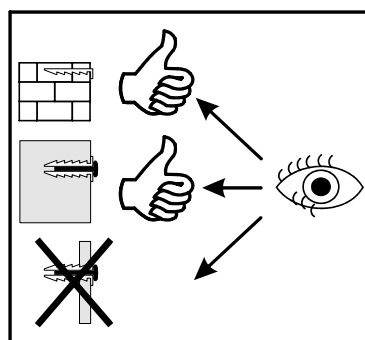
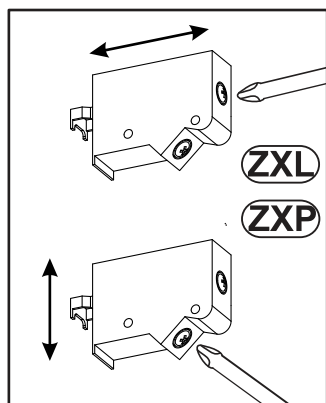
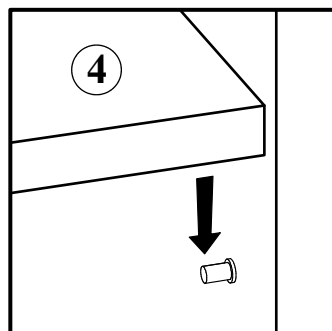
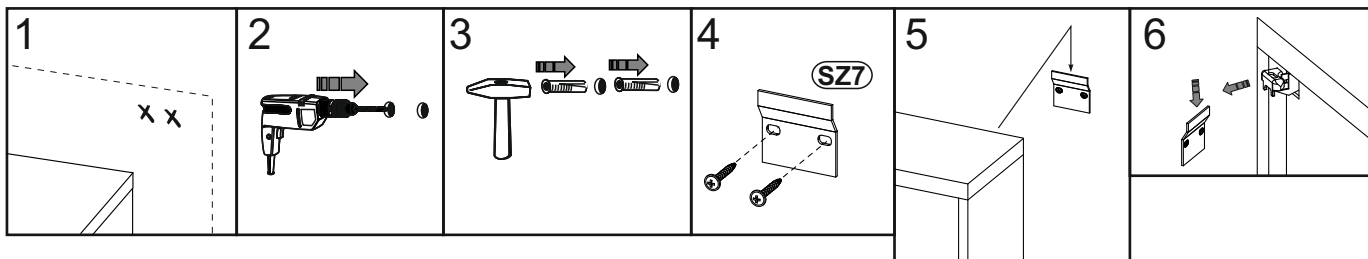
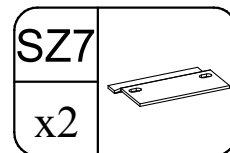
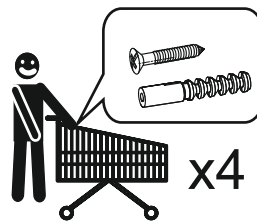

SZAFKA WYSOKA  
1 DRZWI 80-30-1D

9

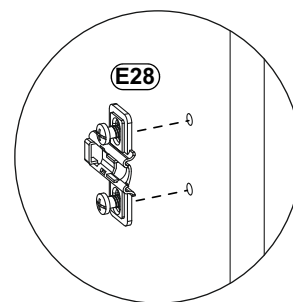
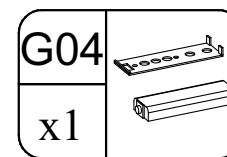
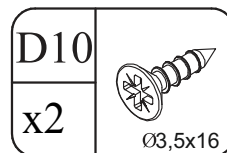
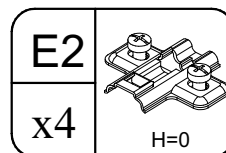
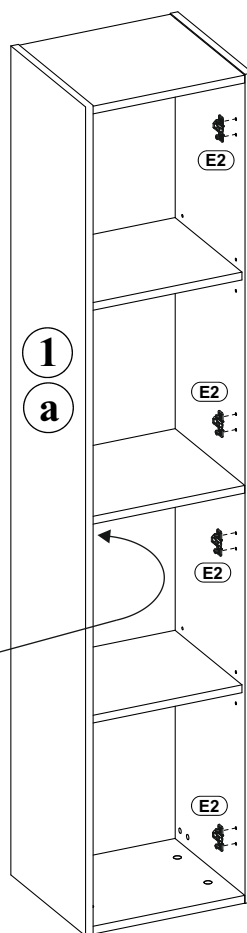
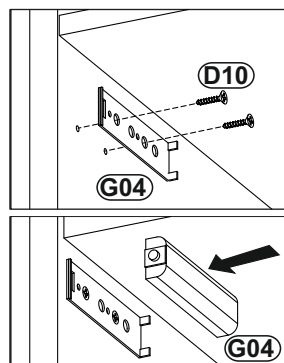
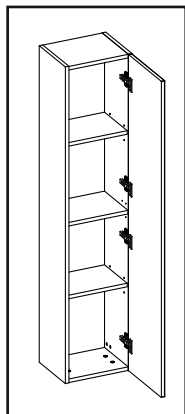

10

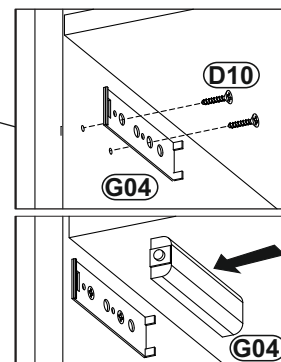
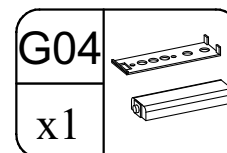
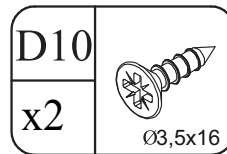
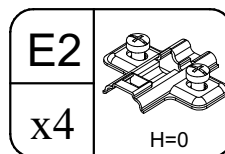
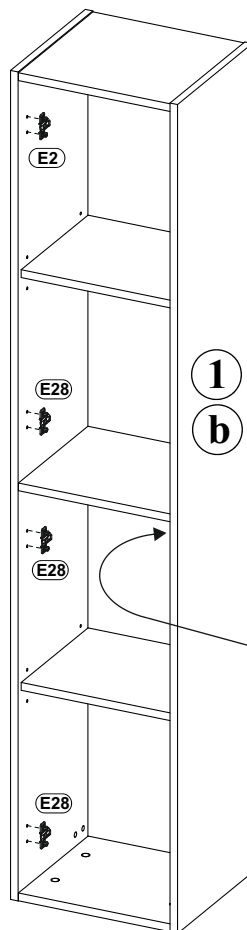
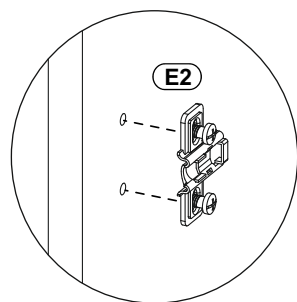
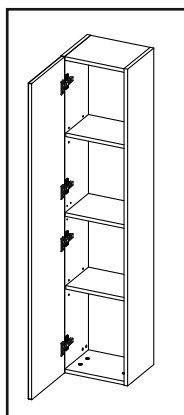

SZAFKA WYSOKA  
1 DRZWI 80-30-1D

11

